

Technical data sheet

Spacer sleeve for insulated ceilings



Item number: 7205909



The spacer sleeves for mounting suspension brackets under insulated ceilings prevent the insulation from denting when the fastening screws are tightened.

Burr-free, galvanised internally and externally.

- St** Steel
- FT** Hot-dip galvanised

Master data

Item number	7205909
Type	DHI 140
Description 1	Spacer sleeve
Description 2	for insulated ceilings
Manufacturer	OBO
Dimension	33,7x140x3mm
Material	Steel
Surface	Hot-dip galvanised
Surface standard	DIN EN ISO 1461
Smallest sales unit	12
Unit of quantity	Piece
Weight	32.8 kg
Weight unit	kg/100 pc.

Technical data sheet

Spacer sleeve for insulated ceilings

Item number: 7205909



Dimensions

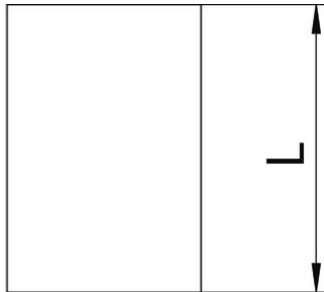

Length	140 mm
Dimension L	140 mm

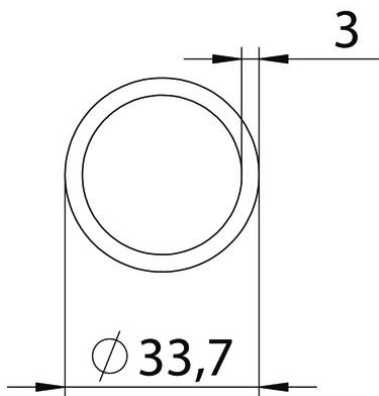

Technical data

Inner diameter	27.7 mm
----------------	---------