

Technical data sheet

Cover, angle-adjustable bend FS

Item number: 6037508



Cover for angle-adjustable bend fitting for lockable and screw-on cable trays in indoor areas, to protect cables against damage and soiling. Fastening with pre-mounted sash locks and through attachment of the section cover. Suitable for all side heights.

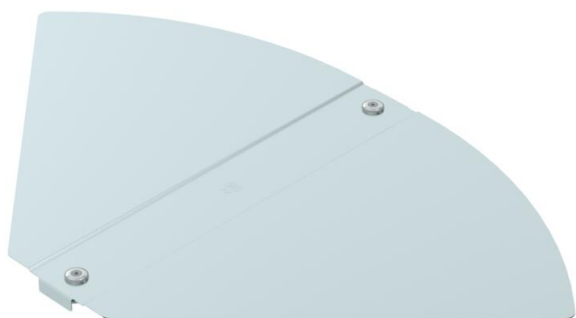

St Steel

FS Strip galvanized

Master data

Item number	6037508
Type	RBD W 400 FS
Description 1	Cover
Description 2	for bend, adjustable
Manufacturer	OBO
Dimension	B400mm
Material	Steel
Surface	Strip galvanized
Surface standard	DIN EN 10346
Smallest sales unit	1
Unit of quantity	Piece
Weight	135 kg
Weight unit	kg/100 pc.

Technical data sheet

Cover, angle-adjustable bend FS

Item number: 6037508



Dimensions

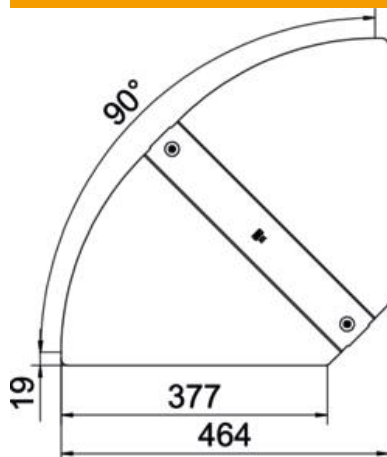

Width	400 mm
Plate thickness	1 mm

Technical data

Bend (angle)	Adjustable
Number of turn buckles	2 St.
Fastening type	Sash lock
Maintain electrical functions	no
Suitable for mesh cable tray	no
Suitable for cable ladder	no
Suitable for cable tray	yes
Change of direction	Horizontal
Rustproof steel, pickled	no
Hinged	no
Permitted temperature range, max.	120 °C
Permitted temperature range, min.	-20 °C