

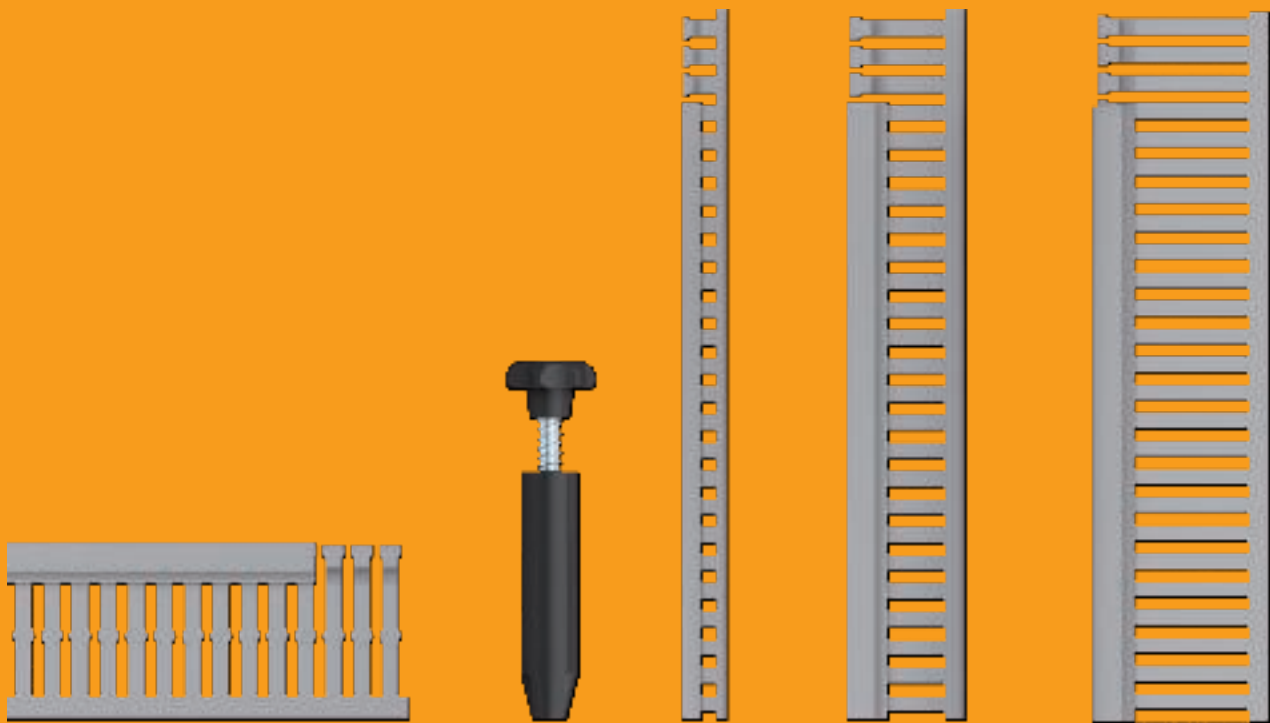

## Bedradingskokers



# OBO bedradingskokers



Een ongewoon breed programma met producten in de bekende hoge kwaliteit: de bedradingskokers zorgen voor een praktische installatie van kabels in de schakelkast. Alle kanalen zijn van loodvrij materiaal gefabriceerd. Voor optimale veiligheid hebben zij een programma halogeenvrije kanalen in het assortiment.

Voor de professionele bedradingsinstallatie staan de VK bedradingskokers ter beschikking in de afmetingen 15 x 15 mm tot 100 x 100 mm. Zachte, braamvrije sleuven en afgeronde tongen vergemakkelijken de montage en voorkomen verwondingen. Op aanvraag leveren wij ook speciale uitvoeringen.

**OBO**  
BETTERMANN

# Exacte maten en beproefde kwaliteit.

De bedradingskokers LK4 en LK4/N en ook LKV en LKV/N hebben nauwkeurig voorbereide breukplaatsen voor het eenvoudig uitbreken van de zijschotten. Alle types hebben, afhankelijk van de grootte, één of twee rijen bodemperforatie. Verjongingen in de zijgleuven van de typen LK4/N en LKV/N voorkomen dat de kabels uit de koker vallen.

## LK4

Nominale maten zijn binnenmaten

## LKV

Alleen buitenmaten

### Gecertificeerd

De bedradingskokers zijn VDE-getest en UL-gecertificeerd (UL File E301798).



### LK4 en LK4/N

OBO levert de bedradingskoker LK4 in de afmetingen 15 x 15 mm tot 80 x 120 mm. Het deksel zit goed vast, toch kan het eenvoudig worden afgenomen om het kanaal te openen.



### LKV en LKV/N

Dankzij hun speciale vorm passen de deksels ook perfect op de LKV bedradingskokers. De LKV is leverbaar in de afmetingen 25 x 25 mm tot 100 x 100 mm (DIN EN 50085-2-3) en voldoet zo aan elke wens.



### LKV/H

De LKV/H bedradingskoker is halogeenvrij en leverbaar in acht verschillende afmetingen van 50 x 37,5 mm tot 75 x 125 mm.

**HALOGEN  
FREE**

- Geringe rookontwikkeling
- Geringe toxiciteit van de rookgassen
- Nauwelijks vrijkomen van corrosieve gassen

# Opbouwsysteem Bedradingskokers



OBO bedradingskokers overtuigen met vele voordelen, welke zich in de schakelkastbouw al lange tijd hebben bewezen. Ook in continu bedrijf waarborgen deze de betrouwbare verbindingen en de goede werking van de elektrotechnische infrastructuur.

1

Stabiele kanalen met kwalitatieve wanddikten.

2

Exacte breukplaatsen dwars en in de bodem

3

Zachte, braamvrije sleuven, afgeronde tongen

4

Absolute maatvoering van de zijperforatie en de bodemperforatie

5

Snijkanten in afsluitbereik braamvrij afgerond

6

Vaste bevestiging van de deksel door optimale afsluitcontouren

7

Draadbevestigingslip, maakt bedrading zonder draadklem mogelijk en voorkomt uitvallen van al geïnstalleerde draden



## Speciale oplossingen

- Beginmaat van de bodemperforatie variabel instelbaar
- Levering zonder bodemperforatie
- Speciale lengten
- Speciale kleuren

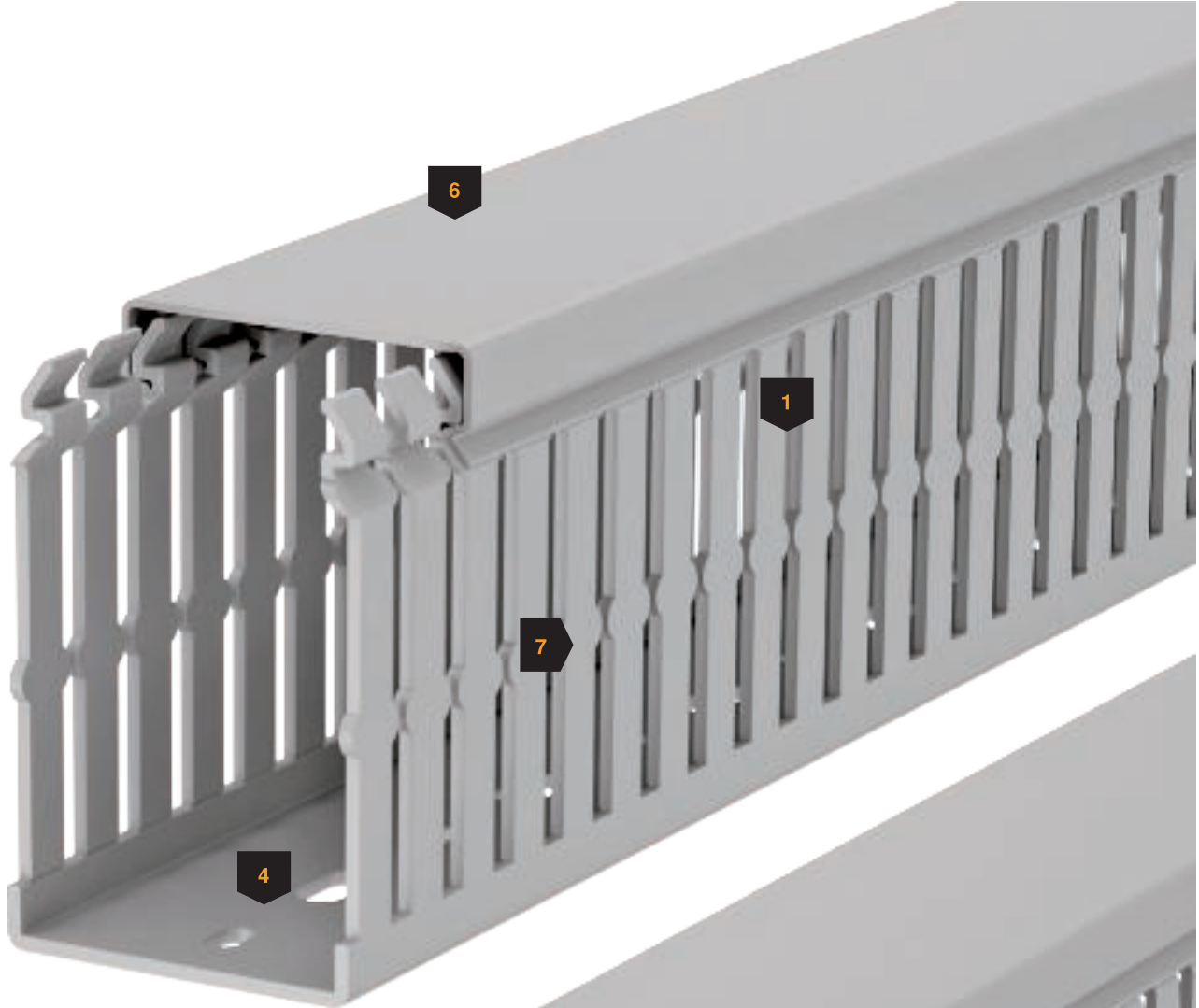

### **Uitbreektang**

Met behulp van de uitbreektang kunnen de lamellen tot aan de kanaalbodem worden afgebroken. Na het uitbreken van de zijschotten ontstaat geen volumeverlies in de overgangszone naar het aansluitende kanaal.



### Montage bedradingskoker

Met behulp van de splijtnagels wordt de bedradingskoker op de montageplaat van de schakelkast bevestigd. De splijtnagels worden met het kunststof nietapparaat gemonteerd.



### Montage afstandshouder

Met de afstandshouder kan de bedradingskoker vanaf de montageplaat verhoogd gemonteerd worden.



### Montage draadhouder

De draadhouder wordt in de zijleuf van de bedradingskokers ingebracht. Deze vergemakkelijkt de installatie van de kabel en houdt deze vast in de bedradingskoker. Hierdoor wordt het eenvoudiger om het deksel te plaatsen. Bij een eventuele installatie achteraf worden de kabels bij het wegnemen van het deksel in het kanaal vastgehouden zodat ze er niet uit vallen.



### Draadhouders

De draadhouderbruggen kunnen aan de kanaalbreedte worden aangepast. Hiervoor wordt de draadhouderbrug op de breukplaatsen afgebroken. Daardoor is slechts één draadhouderbrug voor alle kanaalbreedtes nodig.



### **Bodemperforatie**

Een- en tweespoor bodemperforatie conform DIN 43659 maken exact werken mogelijk.

### **Speciale oplossing**

Beginmaat van de vloerperforatie variabel instelbaar naar wens van de klant



### **Identificatieplaatje**

Sticker als markering voor het aanbrengen op bedradingskokers in schakelkasten waarin intrinsiekveilige circuits worden geïnstalleerd.



# Gatenpatroon en maatvoering

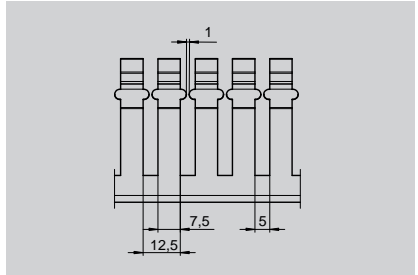
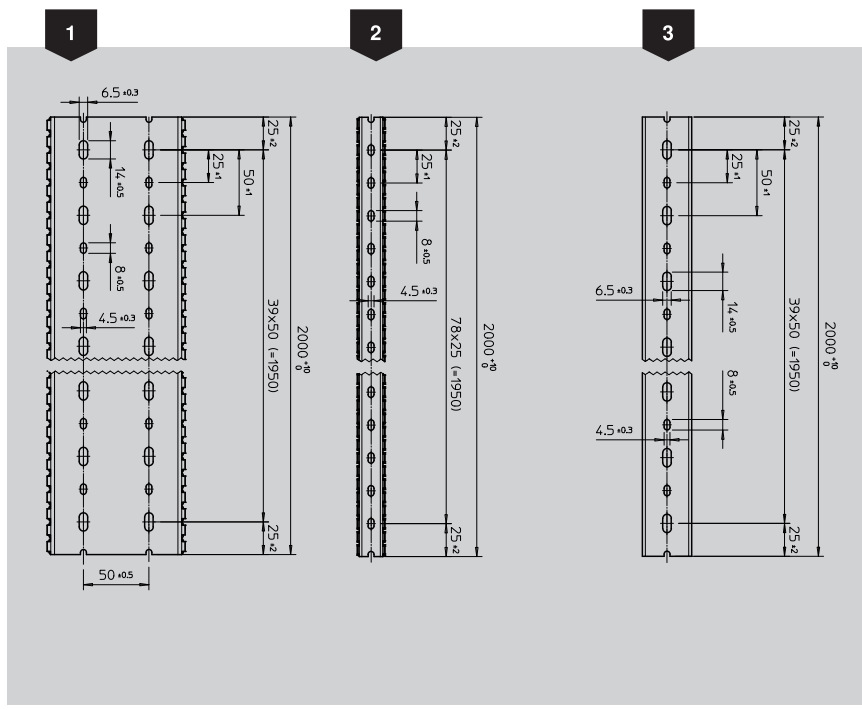

LKV

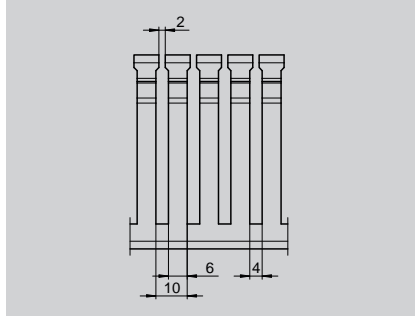

LK4

Alle VK- en VKH-bedradingskokers beginnen en eindigen, gerelateerd aan een leveringslengte (2000 mm), altijd met een half (4,5 x 8 mm) bevestigingsgat.

LK4/LK4/N	Art.nr.	Gatenpatroon
LK4 15015	6178001	2
LK4 30015	6178003	2
LK4 30025	6178005	3
LK4 40025	6178010	3
LK4 40040	6178012	3
LK4 40060	6178014	3
LK4 40080	6178016	1
LK4 40100	6178018	1
LK4 60015	6178026	2
LK4/N 60015	6178201	2
LK4 60025	6178028	3
LK4/N 60025	6178203	3
LK4 60040	6178031	3
LK4/N 60040	6178205	3
LK4 60060	6178033	3
LK4/N 60060	6178207	3
LK4 60080	6178035	1
LK4/N 60080	6178209	1
LK4 60100	6178037	1
LK4/N 60100	6178211	1
LK4 60120	6178039	1
LK4/N 60120	6178213	1

LK4/LK4/N	Art.nr.	Gatenpatroon
LK4 80025	6178050	3
LK4/N 80025	6178225	3
LK4 80040	6178052	3
LK4/N 80040	6178227	3
LK4 80060	6178054	3
LK4/N 80060	6178229	3
LK4 80080	6178056	1
LK4/N 80080	6178231	1
LK4 80100	6178059	1
LK4/N 80100	6178233	1
LK4/N 80120	6178236	1
LK4/N 80120	6178236	1
LK4/N 80120	6178236	1

LKV/H	Art.nr.	Gatenpatroon
LKVH 50037	6178582	3
LKVH 50050	6178585	3
LKVH 50075	6178588	1
LKVH N 75037	6178552	3
LKVH N 75050	6178556	3
LKVH N 75075	6178559	1
LKVH N 75100	6178563	1
LKVH N 75125	6178566	1

LKV/LKV/N	Art.nr.	Gatenpatroon
LKV 25025	6178302	3
LKV 37025	6178305	3
LKV 37037	6178307	3
LKV 50025	6178310	3
LKV 50037	6178312	3
LKV 50050	6178314	3
LKV 50075	6178316	1

LKV/LKV/N	Art.nr.	Gatenpatroon
LKV 75025	6178320	3
LKV/N 75025	6178420	3
LKV 75037	6178322	3
LKV/N 75037	6178422	3
LKV 75050	6178324	3
LKV/N 75050	6178424	3
LKV 75075	6178326	1
LKV/N 75075	6178426	1
LKV 75100	6178328	1
LKV/N 75100	6178428	1
LKV 75125	6178330	1
LKV/N 75125	6178430	1
LKV 10037	6178334	3
LKV/N 10037	6178435	3
LKV 10050	6178336	3
LKV/N 10050	6178437	3
LKV 10075	6178338	1
LKV/N 10075	6178439	1
LKV 100100	6178341	1

# Afmeting bedradingskoker LK4

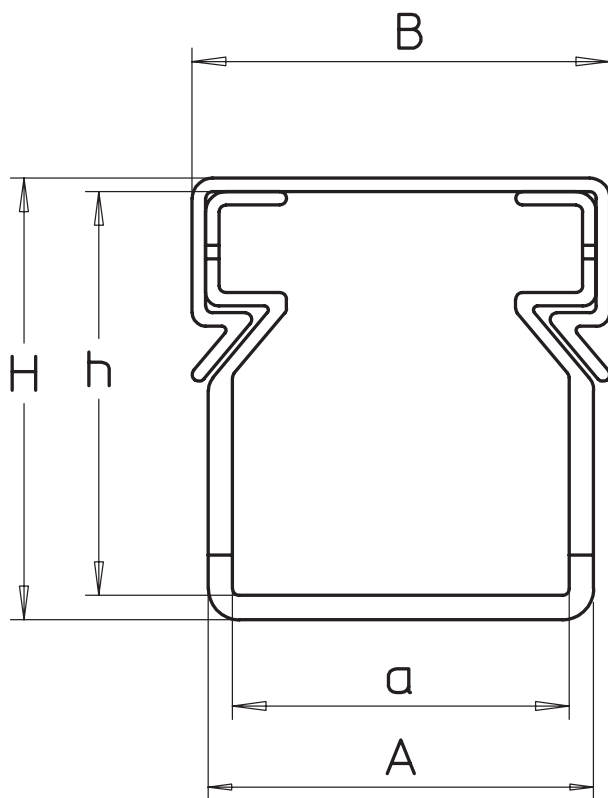

## Afmetingen LK4

Art.nr.	Type	Art.nr.	Type	Maat a mm	Maat A mm	Maat B mm	Maat h mm	Maat H mm
6178001	LK4 15015			15	17	20	15	17
6178003	LK4 30015			15	17,8	20	30	32,4
6178005	LK4 30025			25	28,6	31	30	32,8
6178010	LK4 40025			25	28,6	31	40	42,8
6178012	LK4 40040			40	43,6	46,2	40	43
6178014	LK4 40060			60	64	66,4	40	43,2
6178016	LK4 40080			80	84	87	40	43,5
6178018	LK4 40100			100	104	107,4	40	43,7
6178026	LK4 60015	6178201	LK4 N 60015	15	18,6	20	60	62,8
6178028	LK4 60025	6178203	LK4 N 60025	25	29	31	60	63
6178031	LK4 60040	6178205	LK4 N 60040	40	44	46,2	60	63
6178033	LK4 60060	6178207	LK4 N 60060	60	64	66,4	60	63,2
6178035	LK4 60080	6178209	LK4 N 60080	80	84,4	87	60	63,7
6178037	LK4 60100	6178211	LK4 N 60100	100	104,6	107,4	60	64
6178039	LK4 60120	6178213	LK4 N 60120	120	124,6	127,8	60	64,2
6178050	LK4 80025	6178225	LK4 N 80025	25	29,4	31	80	83,2
6178052	LK4 80040	6178227	LK4 N 80040	40	44,4	46,2	80	83,3
6178054	LK4 80060	6178229	LK4 N 80060	60	64,4	66,4	80	83,4
6178056	LK4 80080	6178231	LK4 N 80080	80	84,6	87	80	83,9
6178059	LK4 80100	6178233	LK4 N 80100	100	104,8	107,4	80	84,1
6178061	LK4 80120	6178236	LK4 N 80120	120	124,8	127,8	80	84,3

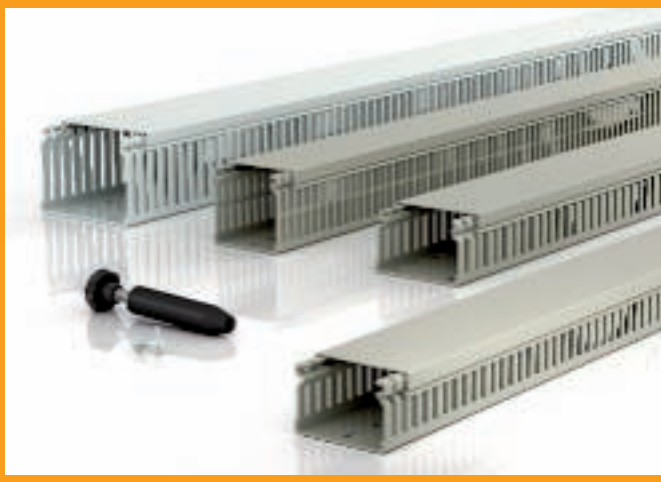

VK bedradingskoker

## VK bedradingskokersysteem

	<b>LK4 bedradingskoker</b>	14
	<b>LK4/N bedradingskoker met draadbevestiging</b>	20
	<b>LKV DIN bedradingskoker</b>	24
	<b>LKV/N DIN bedradingskoker met draadbevestiging</b>	29
	<b>Toebehoren</b>	32

### Bedradingskoker, type LK4 15015

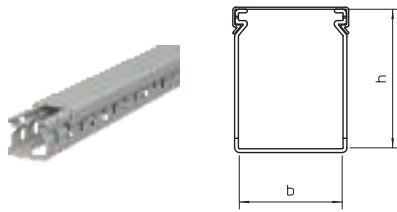

Type	Kleur	Lengte mm	B x H mm	Verp. m	Gewicht kg/100 m	Bestelnr.
LK4 15015	steengrijs	2000	15x15	72	12,000	6178001

PVC Polyvinylchloride €/m

### Deksel

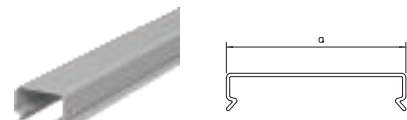

Type	Kleur	Afmeting a mm	Lengte mm	Verp. m	Gewicht kg/100 m	Bestelnr.
LK4 D 15	steengrijs	20	2000	92	8,500	6178480

PVC Polyvinylchloride €/m

### Deksel

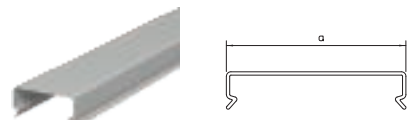

Type	Kleur	Afmeting a mm	Lengte mm	Verp. m	Gewicht kg/100 m	Bestelnr.
LK4 D 25	steengrijs	31	2000	32	10,000	6178482

PVC Polyvinylchloride €/m

### Deksel

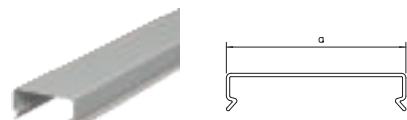

Type	Kleur	Afmeting a mm	Lengte mm	Verp. m	Gewicht kg/100 m	Bestelnr.
LK4 D 25	steengrijs	31	2000	32	10,000	6178482

PVC Polyvinylchloride €/m

### Bedradingskoker, type LK4 30015

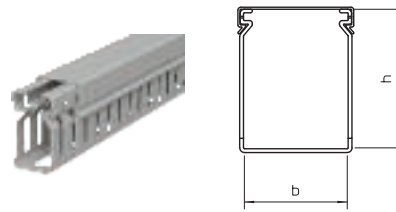

Type	Kleur	Lengte mm	B x H mm	Verp. m	Gewicht kg/100 m	Bestelnr.
LK4 30015	steengrijs	2000	15x30	40	18,000	6178003

PVC Polyvinylchloride €/m

### Bedradingskoker, type LK4 30025

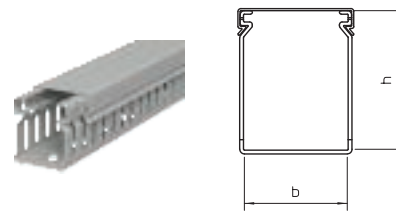

Type	Kleur	Lengte mm	B x H mm	Verp. m	Gewicht kg/100 m	Bestelnr.
LK4 30025	steengrijs	2000	25x30	48	28,000	6178005

PVC Polyvinylchloride €/m

### Bedradingskoker, type LK4 40025

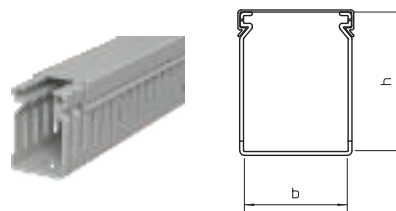

Type	Kleur	Lengte mm	B x H mm	Verp. m	Gewicht kg/100 m	Bestelnr.
LK4 40025	steengrijs	2000	25x40	48	36,500	6178010

PVC Polyvinylchloride €/m

### Bedradingskoker, type LK4 40040

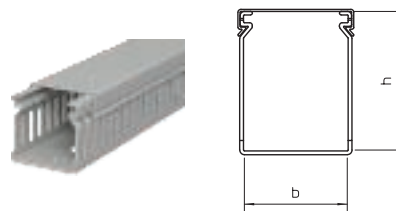

Type	Kleur	Lengte mm	B x H mm	Verp. m	Gewicht kg/100 m	Bestelnr.
LK4 40040	steengrijs	2000	40x40	36	44,000	6178012

PVC Polyvinylchloride €/m

### Deksel

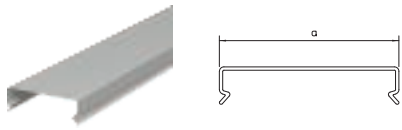

Type	Kleur	Afmeting a mm	Lengte mm	Verp. m	Gewicht kg/100 m	Bestelnr.
<b>LK4 D 40</b>	steengrijs	46,2	2000	24	13,500	<b>6178484</b>
PVC Polyvinylchloride € / m						

### Deksel

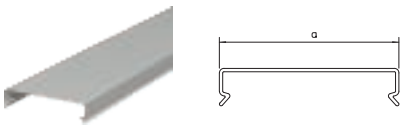

Type	Kleur	Afmeting a mm	Lengte mm	Verp. m	Gewicht kg/100 m	Bestelnr.
<b>LK4 D 60</b>	steengrijs	66,4	2000	40	18,000	<b>6178486</b>
PVC Polyvinylchloride € / m						

### Deksel

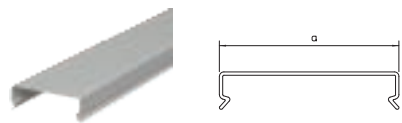

Type	Kleur	Afmeting a mm	Lengte mm	Verp. m	Gewicht kg/100 m	Bestelnr.
<b>LK4 D 80</b>	steengrijs	87	2000	12	27,000	<b>6178488</b>
PVC Polyvinylchloride € / m						

### Deksel

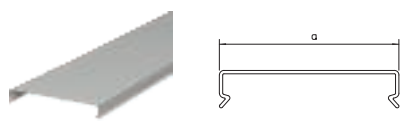

Type	Kleur	Afmeting a mm	Lengte mm	Verp. m	Gewicht kg/100 m	Bestelnr.
<b>LK4 D 100</b>	steengrijs	107,4	2000	12	35,500	<b>6178490</b>
PVC Polyvinylchloride € / m						

### Bedradingskoker, type LK4 40060

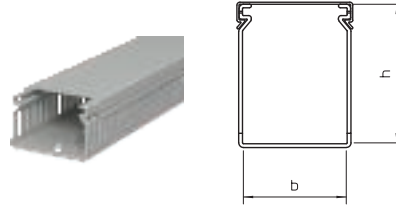

Type	Kleur	Lengte mm	Afmeting B x H mm	Verp. m	Gewicht kg/100 m	Bestelnr.
<b>LK4 40060</b>	steengrijs	2000	60x40	24	57,000	<b>6178014</b>
PVC Polyvinylchloride € / m						

### Bedradingskoker, type LK4 40080

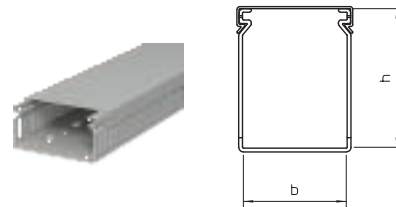

Type	Kleur	Lengte mm	Afmeting B x H mm	Verp. m	Gewicht kg/100 m	Bestelnr.
<b>LK4 40080</b>	steengrijs	2000	80x40	24	71,000	<b>6178016</b>
PVC Polyvinylchloride € / m						

### Bedradingskoker, type LK4 40100

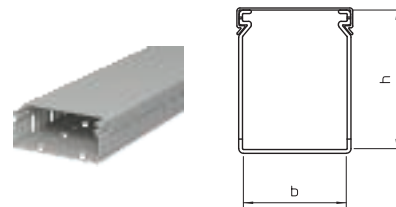

Type	Kleur	Lengte mm	Afmeting B x H mm	Verp. m	Gewicht kg/100 m	Bestelnr.
<b>LK4 40100</b>	steengrijs	2000	100x40	24	85,500	<b>6178018</b>
PVC Polyvinylchloride € / m						

### Bedradingskoker, type LK4 60015

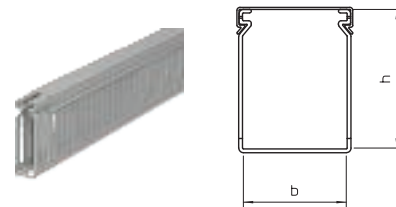

Type	Kleur	Lengte mm	Afmeting B x H mm	Verp. m	Gewicht kg/100 m	Bestelnr.
<b>LK4 60015</b>	steengrijs	2000	15x60	48	32,500	<b>6178026</b>
PVC Polyvinylchloride € / m						

**Deksel**

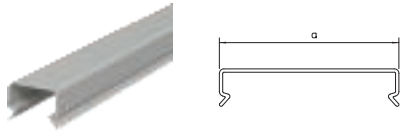

Type	Kleur	Afmeting a mm	Lengte mm	Verp. m	Gewicht kg/100 m	Bestelnr.
<b>LK4 D 15</b>	steengrijs	20	2000	92	8,500	<b>6178480</b>
PVC Polyvinylchloride € / m						

**Deksel**

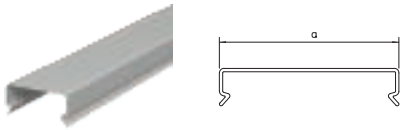

Type	Kleur	Afmeting a mm	Lengte mm	Verp. m	Gewicht kg/100 m	Bestelnr.
<b>LK4 D 25</b>	steengrijs	31	2000	32	10,000	<b>6178482</b>
PVC Polyvinylchloride € / m						

**Deksel**

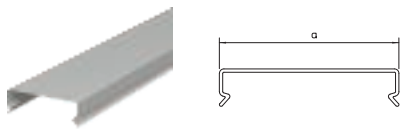

Type	Kleur	Afmeting a mm	Lengte mm	Verp. m	Gewicht kg/100 m	Bestelnr.
<b>LK4 D 40</b>	steengrijs	46,2	2000	24	13,500	<b>6178484</b>
PVC Polyvinylchloride € / m						

**Deksel**

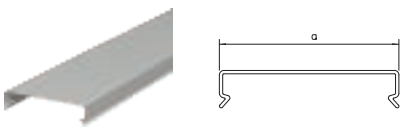

Type	Kleur	Afmeting a mm	Lengte mm	Verp. m	Gewicht kg/100 m	Bestelnr.
<b>LK4 D 60</b>	steengrijs	66,4	2000	40	18,000	<b>6178486</b>
PVC Polyvinylchloride € / m						

**Bedradingskoker, type LK4 60025**

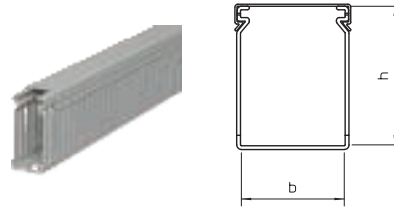

Type	Kleur	Lengte mm	Afmeting B x H mm	Verp. m	Gewicht kg/100 m	Bestelnr.
<b>LK4 60025</b>	steengrijs	2000	25x60	32	46,000	<b>6178028</b>
PVC Polyvinylchloride € / m						

**Bedradingskoker, type LK4 60040**

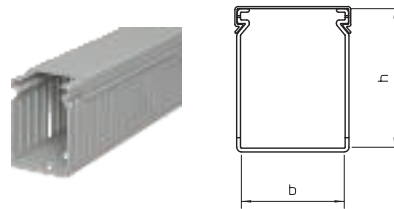

Type	Kleur	Lengte mm	Afmeting B x H mm	Verp. m	Gewicht kg/100 m	Bestelnr.
<b>LK4 60040</b>	steengrijs	2000	40x60	24	53,500	<b>6178031</b>
PVC Polyvinylchloride € / m						

**Bedradingskoker, type LK4 60060**

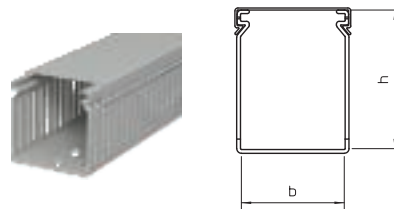

Type	Kleur	Lengte mm	Afmeting B x H mm	Verp. m	Gewicht kg/100 m	Bestelnr.
<b>LK4 60060</b>	steengrijs	2000	60x60	32	64,500	<b>6178033</b>
PVC Polyvinylchloride € / m						

**Bedradingskoker, type LK4 60080**

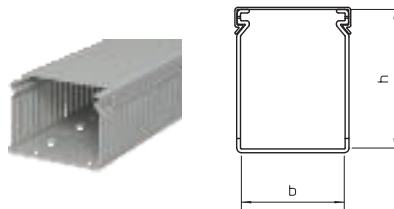

Type	Kleur	Lengte mm	Afmeting B x H mm	Verp. m	Gewicht kg/100 m	Bestelnr.
<b>LK4 60080</b>	steengrijs	2000	80x60	24	82,500	<b>6178035</b>
PVC Polyvinylchloride € / m						



**Deksel**

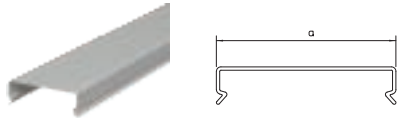

Type	Kleur	Afmeting a mm	Lengte mm	Verp. m	Gewicht kg/100 m	Bestelnr.
<b>LK4 D 80</b>	steengrijs	87	2000	12	27,000	<b>6178488</b>
PVC Polyvinylchloride € / m						

**Deksel**

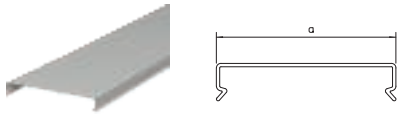

Type	Kleur	Afmeting a mm	Lengte mm	Verp. m	Gewicht kg/100 m	Bestelnr.
<b>LK4 D 100</b>	steengrijs	107,4	2000	12	35,500	<b>6178490</b>
PVC Polyvinylchloride € / m						

**Deksel**

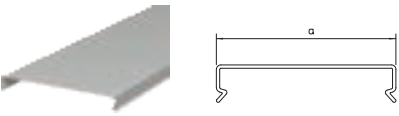

Type	Kleur	Afmeting a mm	Lengte mm	Verp. m	Gewicht kg/100 m	Bestelnr.
<b>LK4 D 120</b>	steengrijs	127,8	2000	16	45,500	<b>6178492</b>
PVC Polyvinylchloride € / m						

**Deksel**

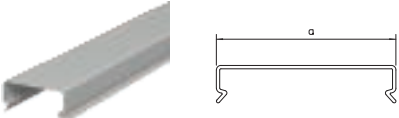

Type	Kleur	Afmeting a mm	Lengte mm	Verp. m	Gewicht kg/100 m	Bestelnr.
<b>LK4 D 25</b>	steengrijs	31	2000	32	10,000	<b>6178482</b>
PVC Polyvinylchloride € / m						

**Bedradingskoker, type LK4 60100**

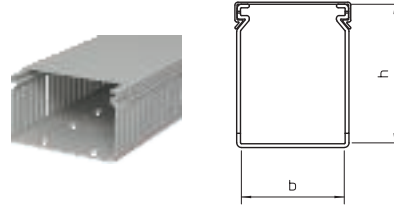

Type	Kleur	Lengte mm	B x H mm	Verp. m	Gewicht kg/100 m	Bestelnr.
<b>LK4 60100</b>	steengrijs	2000	100x60	16	100,000	<b>6178037</b>
PVC Polyvinylchloride € / m						

**Bedradingskoker, type LK4 60120**

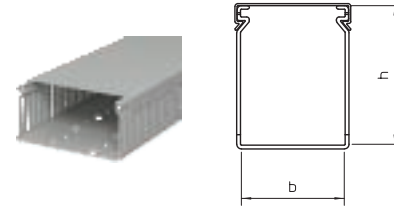

Type	Kleur	Lengte mm	B x H mm	Verp. m	Gewicht kg/100 m	Bestelnr.
<b>LK4 60120</b>	steengrijs	2000	120x60	8	117,000	<b>6178039</b>
PVC Polyvinylchloride € / m						

**Bedradingskoker, type LK4 80025**

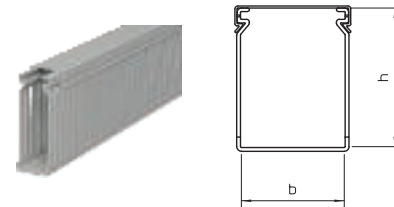

Type	Kleur	Lengte mm	B x H mm	Verp. m	Gewicht kg/100 m	Bestelnr.
<b>LK4 80025</b>	steengrijs	2000	25x80	32	61,000	<b>6178050</b>
PVC Polyvinylchloride € / m						

**Bedradingskoker, type LK4 80040**

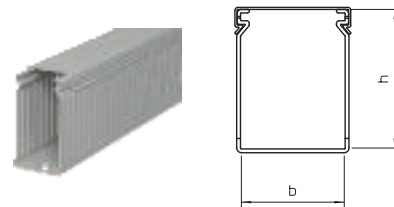

Type	Kleur	Lengte mm	B x H mm	Verp. m	Gewicht kg/100 m	Bestelnr.
<b>LK4 80040</b>	steengrijs	2000	40x80	24	64,500	<b>6178052</b>
PVC Polyvinylchloride € / m						

**Deksel**

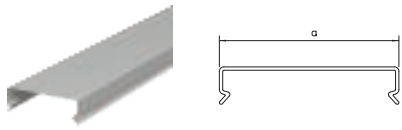

Type	Kleur	Afmeting a mm	Lengte mm	Verp. m	Gewicht kg/100 m	Bestelnr.
<b>LK4 D 40</b>	steengrijs	46,2	2000	24	13,500	<b>6178484</b>
PVC Polyvinylchloride € / m						

**Deksel**

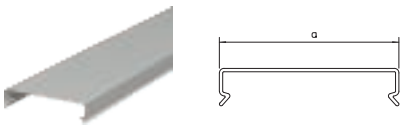

Type	Kleur	Afmeting a mm	Lengte mm	Verp. m	Gewicht kg/100 m	Bestelnr.
<b>LK4 D 60</b>	steengrijs	66,4	2000	40	18,000	<b>6178486</b>
PVC Polyvinylchloride € / m						

**Deksel**

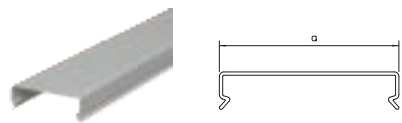

Type	Kleur	Afmeting a mm	Lengte mm	Verp. m	Gewicht kg/100 m	Bestelnr.
<b>LK4 D 80</b>	steengrijs	87	2000	12	27,000	<b>6178488</b>
PVC Polyvinylchloride € / m						

**Deksel**

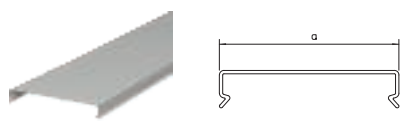

Type	Kleur	Afmeting a mm	Lengte mm	Verp. m	Gewicht kg/100 m	Bestelnr.
<b>LK4 D 100</b>	steengrijs	107,4	2000	12	35,500	<b>6178490</b>
PVC Polyvinylchloride € / m						

**Bedradingskoker, type LK4 80060**

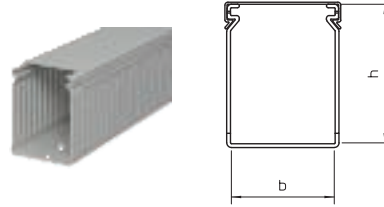

Type	Kleur	Lengte mm	Afmeting B x H mm	Verp. m	Gewicht kg/100 m	Bestelnr.
<b>LK4 80060</b>	steengrijs	2000	60x80	24	76,000	<b>6178054</b>
PVC Polyvinylchloride € / m						

**Bedradingskoker, type LK4 80080**

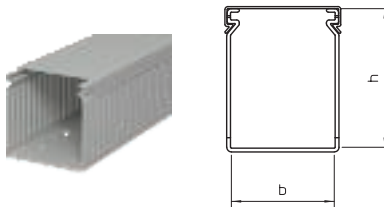

Type	Kleur	Lengte mm	Afmeting B x H mm	Verp. m	Gewicht kg/100 m	Bestelnr.
<b>LK4 80080</b>	steengrijs	2000	80x80	16	95,500	<b>6178056</b>
PVC Polyvinylchloride € / m						

**Bedradingskoker, type LK4 80100**

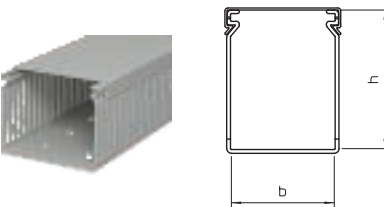

Type	Kleur	Lengte mm	Afmeting B x H mm	Verp. m	Gewicht kg/100 m	Bestelnr.
<b>LK4 80100</b>	steengrijs	2000	100x80	16	111,500	<b>6178059</b>
PVC Polyvinylchloride € / m						

**Bedradingskoker, type LK4 80120**

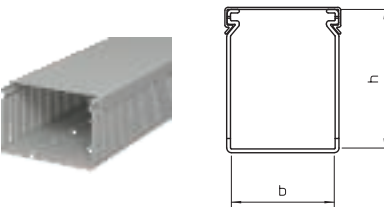

Type	Kleur	Lengte mm	Afmeting B x H mm	Verp. m	Gewicht kg/100 m	Bestelnr.
<b>LK4 80120</b>	steengrijs	2000	120x80	8	128,500	<b>6178061</b>
PVC Polyvinylchloride € / m						

## Deksel

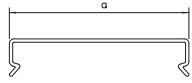

Type	Kleur	Afmeting a mm	Lengte mm	Verp. m	Gewicht kg/100 m	Bestelnr.
<b>LK4 D 120</b>	steengrijs	127,8	2000	16	45,500	<b>6178492</b>
PVC	Polyvinylchloride					€/m

### Bedradingskoker, type LK4/N 60015

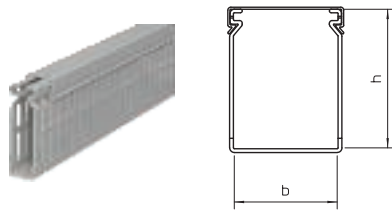

Type	Kleur	Lengte mm	B x H mm	Verp. m	Gewicht kg/100 m	Bestelnr.
LK4 N 60015	steengrijs	2000	15x60	48	41,000	6178201

PVC Polyvinylchloride € / m

### Deksel

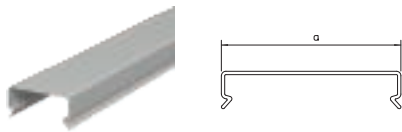

Type	Kleur	Afmeting a mm	Lengte mm	Verp. m	Gewicht kg/100 m	Bestelnr.
LK4 D 25	steengrijs	31	2000	32	10,000	6178482

PVC Polyvinylchloride € / m

### Bedradingskoker, type LK4/N 60040

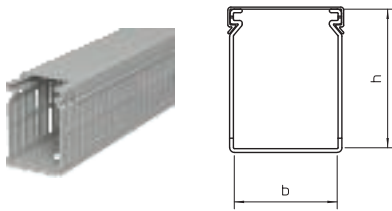

Type	Kleur	Lengte mm	B x H mm	Verp. m	Gewicht kg/100 m	Bestelnr.
LK4 N 60040	steengrijs	2000	40x60	24	56,000	6178205

PVC Polyvinylchloride € / m

### Deksel

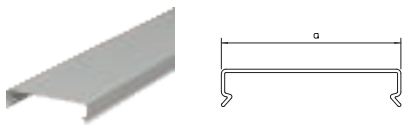

Type	Kleur	Afmeting a mm	Lengte mm	Verp. m	Gewicht kg/100 m	Bestelnr.
LK4 D 60	steengrijs	66,4	2000	40	18,000	6178486

PVC Polyvinylchloride € / m

### Deksel

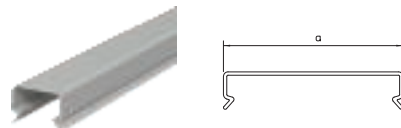

Type	Kleur	Afmeting a mm	Lengte mm	Verp. m	Gewicht kg/100 m	Bestelnr.
LK4 D 15	steengrijs	20	2000	92	8,500	6178480

PVC Polyvinylchloride € / m

### Bedradingskoker, type LK4/N 60025

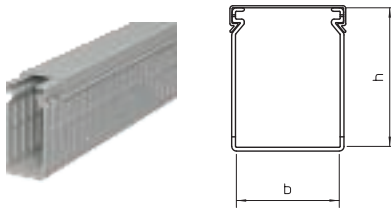

Type	Kleur	Lengte mm	B x H mm	Verp. m	Gewicht kg/100 m	Bestelnr.
LK4 N 60025	steengrijs	2000	25x60	32	48,500	6178203

PVC Polyvinylchloride € / m

### Deksel

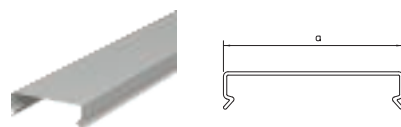

Type	Kleur	Afmeting a mm	Lengte mm	Verp. m	Gewicht kg/100 m	Bestelnr.
LK4 D 40	steengrijs	46,2	2000	24	13,500	6178484

PVC Polyvinylchloride € / m

### Bedradingskoker, type LK4/N 60060

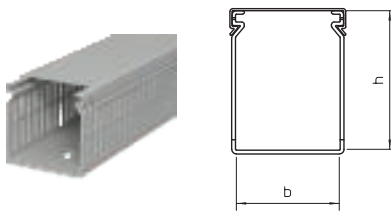

Type	Kleur	Lengte mm	B x H mm	Verp. m	Gewicht kg/100 m	Bestelnr.
LK4 N 60060	steengrijs	2000	60x60	32	68,000	6178207

PVC Polyvinylchloride € / m

### Bedradingskoker, type LK4/N 60080

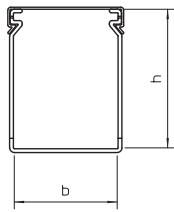

Type	Kleur	Lengte mm	B x H mm	Verp. m	Gewicht kg/100 m	Bestelnr.
LK4 N 60080	steengrijs	2000	80x60	24	87,000	6178209

PVC Polyvinylchloride €/m

### Deksel

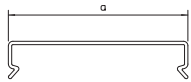

Type	Kleur	Afmeting mm	Lengte mm	Verp. m	Gewicht kg/100 m	Bestelnr.
LK4 D 100	steengrijs	107,4	2000	12	35,500	6178490

PVC Polyvinylchloride €/m

### Bedradingskoker, type LK4/N 60120

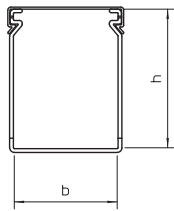

Type	Kleur	Lengte mm	B x H mm	Verp. m	Gewicht kg/100 m	Bestelnr.
LK4 N 60120	steengrijs	2000	120x60	8	120,500	6178213

PVC Polyvinylchloride €/m

### Deksel

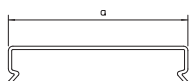

Type	Kleur	Afmeting mm	Lengte mm	Verp. m	Gewicht kg/100 m	Bestelnr.
LK4 D 25	steengrijs	31	2000	32	10,000	6178482

PVC Polyvinylchloride €/m

### Deksel

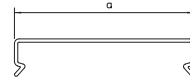

Type	Kleur	Afmeting mm	Lengte mm	Verp. m	Gewicht kg/100 m	Bestelnr.
LK4 D 80	steengrijs	87	2000	12	27,000	6178488

PVC Polyvinylchloride €/m

### Bedradingskoker, type LK4/N 60100

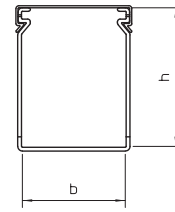

Type	Kleur	Lengte mm	B x H mm	Verp. m	Gewicht kg/100 m	Bestelnr.
LK4 N 60100	steengrijs	2000	100x60	16	105,500	6178211

PVC Polyvinylchloride €/m

### Deksel

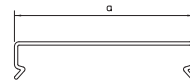

Type	Kleur	Afmeting mm	Lengte mm	Verp. m	Gewicht kg/100 m	Bestelnr.
LK4 D 120	steengrijs	127,8	2000	16	45,500	6178492

PVC Polyvinylchloride €/m

### Bedradingskoker, type LK4/N 80025

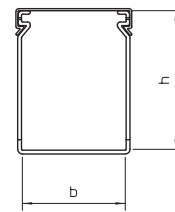

Type	Kleur	Lengte mm	B x H mm	Verp. m	Gewicht kg/100 m	Bestelnr.
LK4 N 80025	steengrijs	2000	25x80	32	65,000	6178225

PVC Polyvinylchloride €/m

### Bedradingskoker, type LK4/N 80040

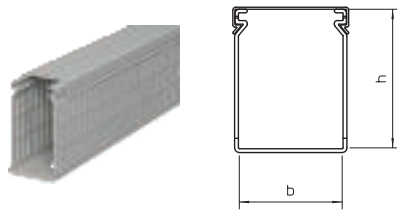

Type	Kleur	Lengte mm	Af-meting B x H mm	Verp. m	Gewicht kg/100 m	Bestelnr.
LK4 N 80040	steengrijs	2000	40x80	24	73,500	6178227

PVC Polyvinylchloride € / m

### Deksel

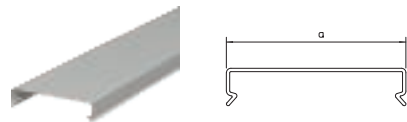

Type	Kleur	Af-meting a mm	Lengte mm	Verp. m	Gewicht kg/100 m	Bestelnr.
LK4 D 60	steengrijs	66,4	2000	40	18,000	6178486

PVC Polyvinylchloride € / m

### Bedradingskoker, type LK4/N 80080

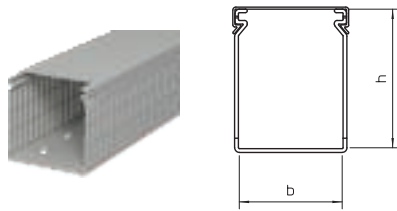

Type	Kleur	Lengte mm	Af-meting B x H mm	Verp. m	Gewicht kg/100 m	Bestelnr.
LK4 N 80080	steengrijs	2000	80x80	16	101,000	6178231

PVC Polyvinylchloride € / m

### Deksel

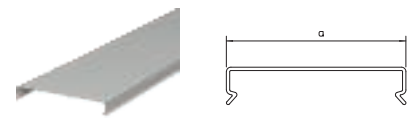

Type	Kleur	Af-meting a mm	Lengte mm	Verp. m	Gewicht kg/100 m	Bestelnr.
LK4 D 100	steengrijs	107,4	2000	12	35,500	6178490

PVC Polyvinylchloride € / m

### Deksel

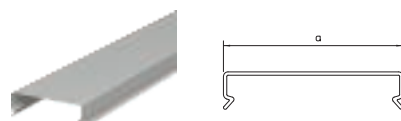

Type	Kleur	Af-meting a mm	Lengte mm	Verp. m	Gewicht kg/100 m	Bestelnr.
LK4 D 40	steengrijs	46,2	2000	24	13,500	6178484

PVC Polyvinylchloride € / m

### Bedradingskoker, type LK4/N 80060

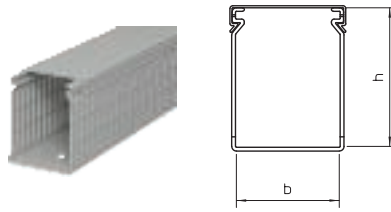

Type	Kleur	Lengte mm	Af-meting B x H mm	Verp. m	Gewicht kg/100 m	Bestelnr.
LK4 N 80060	steengrijs	2000	60x80	24	82,000	6178229

PVC Polyvinylchloride € / m

### Deksel

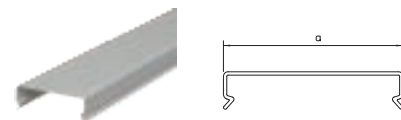

Type	Kleur	Af-meting a mm	Lengte mm	Verp. m	Gewicht kg/100 m	Bestelnr.
LK4 D 80	steengrijs	87	2000	12	27,000	6178488

PVC Polyvinylchloride € / m

### Bedradingskoker, type LK4/N 80100

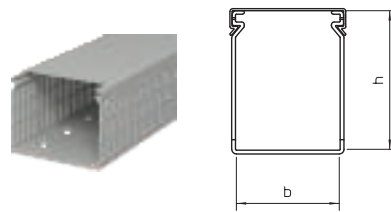

Type	Kleur	Lengte mm	Af-meting B x H mm	Verp. m	Gewicht kg/100 m	Bestelnr.
LK4 N 80100	steengrijs	2000	100x80	16	116,500	6178233

PVC Polyvinylchloride € / m

### Bedradingskoker, type LK4/N 80120

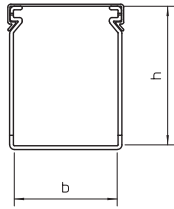

Type	Kleur	Lengte mm	Af- meting B x H mm	Verp. m	Gewicht kg/100 m	Bestelnr.
LK4 N 80120	steengrijs	2000	120x80	8	133,500	6178236
PVC	Polyvinylchloride					€/m

### Deksel

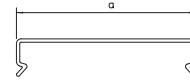

Type	Kleur	Afme- ting a mm	Lengte mm	Verp. m	Gewicht kg/100 m	Bestelnr.
LK4 D 120	steengrijs	127,8	2000	16	45,500	6178492
PVC	Polyvinylchloride					€/m

### Bedradingskoker, type 25025

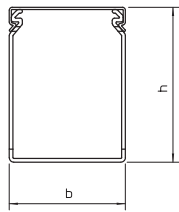

Type	Kleur	Lengte mm	Af-meting B x H mm	Verp. m	Gewicht kg/100 m	Bestelnr.
LKV 25025	steengrijs	2000	25x25	32	24,000	6178302
PVC Polyvinylchloride € / m						

### Deksel

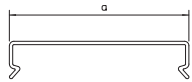

Type	Kleur	Af-meting a mm	Lengte mm	Verp. m	Gewicht kg/100 m	Bestelnr.
LKV D 25	steengrijs	25	2000	36	9,500	6178504
PVC Polyvinylchloride € / m						

### Bedradingskoker, type 37037

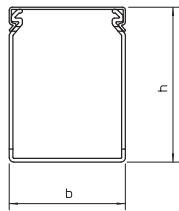

Type	Kleur	Lengte mm	Af-meting B x H mm	Verp. m	Gewicht kg/100 m	Bestelnr.
LKV 37037	steengrijs	2000	37,5x37,5	60	40,500	6178307
PVC Polyvinylchloride € / m						

### Deksel

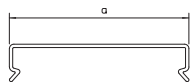

Type	Kleur	Af-meting a mm	Lengte mm	Verp. m	Gewicht kg/100 m	Bestelnr.
LKV D 25	steengrijs	25	2000	36	9,500	6178504
PVC Polyvinylchloride € / m						

### Deksel

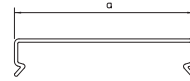

Type	Kleur	Af-meting a mm	Lengte mm	Verp. m	Gewicht kg/100 m	Bestelnr.
LKV D 25	steengrijs	25	2000	36	9,500	6178504
PVC Polyvinylchloride € / m						

### Bedradingskoker, type 37025

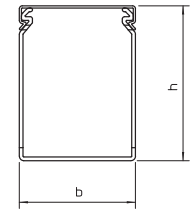

Type	Kleur	Lengte mm	Af-meting B x H mm	Verp. m	Gewicht kg/100 m	Bestelnr.
LKV 37025	steengrijs	2000	25x37,5	32	31,500	6178305
PVC Polyvinylchloride € / m						

### Deksel

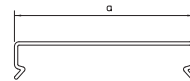

Type	Kleur	Af-meting a mm	Lengte mm	Verp. m	Gewicht kg/100 m	Bestelnr.
LKV D 37	steengrijs	37,5	2000	24	15,000	6178506
PVC Polyvinylchloride € / m						

### Bedradingskoker, type 50025

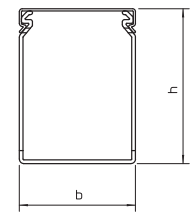

Type	Kleur	Lengte mm	Af-meting B x H mm	Verp. m	Gewicht kg/100 m	Bestelnr.
LKV 50025	steengrijs	2000	25x50	60	35,500	6178310
PVC Polyvinylchloride € / m						



### Bedradingskoker, type 50037

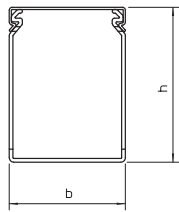

Type	Kleur	Lengte mm	B x H mm	Verp. m	Gewicht kg/100 m	Bestelnr.
LKV 50037	steengrijs	2000	37,5x50	48	44,500	6178312

PVC Polyvinylchloride € / m

### Deksel

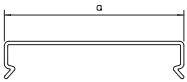

Type	Kleur	Afmeting a mm	Lengte mm	Verp. m	Gewicht kg/100 m	Bestelnr.
LKV D 50	steengrijs	50	2000	24	17,500	6178508

PVC Polyvinylchloride € / m

### Bedradingskoker, type 50075

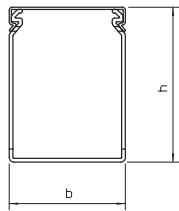

Type	Kleur	Lengte mm	B x H mm	Verp. m	Gewicht kg/100 m	Bestelnr.
LKV 50075	steengrijs	2000	75x50	24	66,000	6178316

PVC Polyvinylchloride € / m

### Deksel

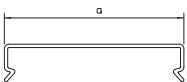

Type	Kleur	Afmeting a mm	Lengte mm	Verp. m	Gewicht kg/100 m	Bestelnr.
LKV D 25	steengrijs	25	2000	36	9,500	6178504

PVC Polyvinylchloride € / m

### Deksel

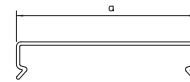

Type	Kleur	Afmeting a mm	Lengte mm	Verp. m	Gewicht kg/100 m	Bestelnr.
LKV D 37	steengrijs	37,5	2000	24	15,000	6178506

PVC Polyvinylchloride € / m

### Bedradingskoker, type 50050

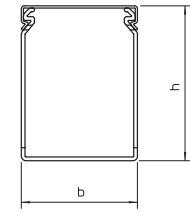

Type	Kleur	Lengte mm	B x H mm	Verp. m	Gewicht kg/100 m	Bestelnr.
LKV 50050	steengrijs	2000	50x50	36	50,000	6178314

PVC Polyvinylchloride € / m

### Deksel

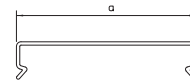

Type	Kleur	Afmeting a mm	Lengte mm	Verp. m	Gewicht kg/100 m	Bestelnr.
LKV D 75	steengrijs	75	2000	12	23,000	6178510

PVC Polyvinylchloride € / m

### Bedradingskoker, type 75025

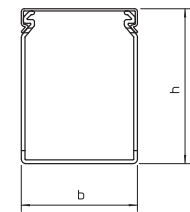

Type	Kleur	Lengte mm	B x H mm	Verp. m	Gewicht kg/100 m	Bestelnr.
LKV 75025	steengrijs	2000	25x75	40	48,500	6178320

PVC Polyvinylchloride € / m

### Bedradingskoker, type 75037

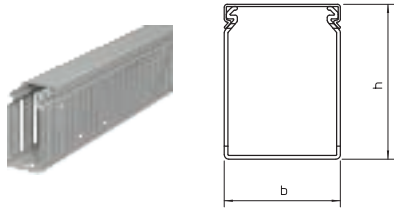

Type	Kleur	Lengte mm	B x H mm	Verp. m	Gewicht kg/100 m	Bestelnr.
LKV 75037	steengrijs	2000	37,5x75	32	58,500	6178322
PVC Polyvinylchloride € / m						

### Deksel

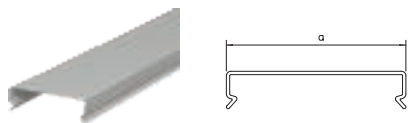

Type	Kleur	Afmeting a mm	Lengte mm	Verp. m	Gewicht kg/100 m	Bestelnr.
LKV D 50	steengrijs	50	2000	24	17,500	6178508
PVC Polyvinylchloride € / m						

### Bedradingskoker, type 75075

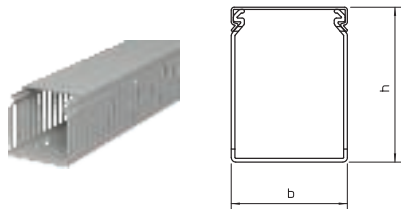

Type	Kleur	Lengte mm	B x H mm	Verp. m	Gewicht kg/100 m	Bestelnr.
LKV 75075	steengrijs	2000	75x75	16	80,000	6178326
PVC Polyvinylchloride € / m						

### Deksel

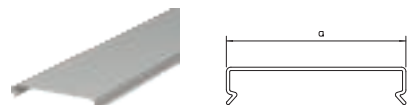

Type	Kleur	Afmeting a mm	Lengte mm	Verp. m	Gewicht kg/100 m	Bestelnr.
LKV D 100	steengrijs	100	2000	12	34,500	6178512
PVC Polyvinylchloride € / m						

### Deksel

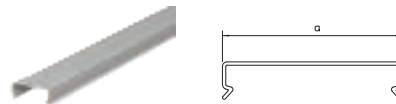

Type	Kleur	Afmeting a mm	Lengte mm	Verp. m	Gewicht kg/100 m	Bestelnr.
LKV D 37	steengrijs	37,5	2000	24	15,000	6178506
PVC Polyvinylchloride € / m						

### Bedradingskoker, type 75050

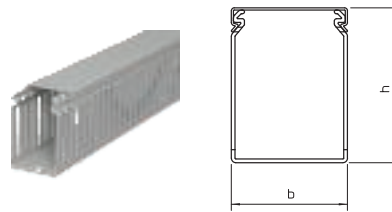

Type	Kleur	Lengte mm	B x H mm	Verp. m	Gewicht kg/100 m	Bestelnr.
LKV 75050	steengrijs	2000	50x75	24	67,500	6178324
PVC Polyvinylchloride € / m						

### Deksel

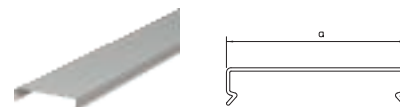

Type	Kleur	Afmeting a mm	Lengte mm	Verp. m	Gewicht kg/100 m	Bestelnr.
LKV D 75	steengrijs	75	2000	12	23,000	6178510
PVC Polyvinylchloride € / m						

### Bedradingskoker, type 75100

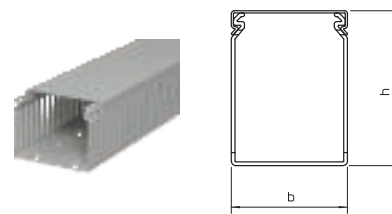

Type	Kleur	Lengte mm	B x H mm	Verp. m	Gewicht kg/100 m	Bestelnr.
LKV 75100	steengrijs	2000	100x75	16	105,500	6178328
PVC Polyvinylchloride € / m						

### Bedradingskoker, type 75125

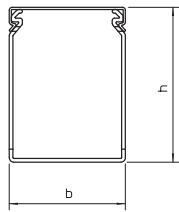

Type	Kleur	Lengte mm	B x H mm	Verp. m	Gewicht kg/100 m	Bestelnr.
<b>LKV 75125</b>	steengrijs	2000	125x75	8	128,500	<b>6178330</b>
PVC Polyvinylchloride € / m						

### Deksel

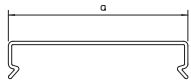

Type	Kleur	Afme- ting a mm	Lengte mm	Verp. m	Gewicht kg/100 m	Bestelnr.
<b>LKV D 37</b>	steengrijs	37,5	2000	24	15,000	<b>6178506</b>
PVC Polyvinylchloride € / m						

### Bedradingskoker, type 10050

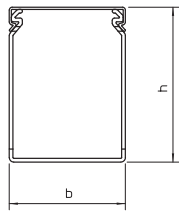

Type	Kleur	Lengte mm	B x H mm	Verp. m	Gewicht kg/100 m	Bestelnr.
<b>LKV 10050</b>	steengrijs	2000	50x100	24	77,000	<b>6178336</b>
PVC Polyvinylchloride € / m						

### Deksel

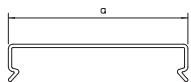

Type	Kleur	Afme- ting a mm	Lengte mm	Verp. m	Gewicht kg/100 m	Bestelnr.
<b>LKV D 75</b>	steengrijs	75	2000	12	23,000	<b>6178510</b>
PVC Polyvinylchloride € / m						

### Deksel

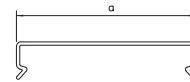

Type	Kleur	Afme- ting a mm	Lengte mm	Verp. m	Gewicht kg/100 m	Bestelnr.
<b>LKV D 125</b>	steengrijs	125	2000	16	47,000	<b>6178514</b>
PVC Polyvinylchloride € / m						

### Bedradingskoker, type 10037

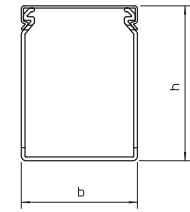

Type	Kleur	Lengte mm	B x H mm	Verp. m	Gewicht kg/100 m	Bestelnr.
<b>LKV 10037</b>	steengrijs	2000	37,5x100	32	67,000	<b>6178334</b>
PVC Polyvinylchloride € / m						

### Deksel

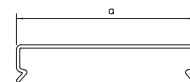

Type	Kleur	Afme- ting a mm	Lengte mm	Verp. m	Gewicht kg/100 m	Bestelnr.
<b>LKV D 50</b>	steengrijs	50	2000	24	17,500	<b>6178508</b>
PVC Polyvinylchloride € / m						

### Bedradingskoker, type 10075

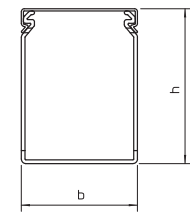

Type	Kleur	Lengte mm	B x H mm	Verp. m	Gewicht kg/100 m	Bestelnr.
<b>LKV 10075</b>	steengrijs	2000	75x100	16	96,000	<b>6178338</b>
PVC Polyvinylchloride € / m						

### Bedradingskoker, type 100100

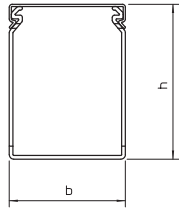

Type	Kleur	Lengte mm	Af- meting B x H mm	Verp. m	Gewicht kg/100 m	Bestelnr.
LKV 100100	steengrijs	2000	100x100	8	116,500	6178341
PVC Polyvinylchloride € / m						

### Deksel

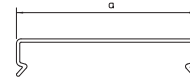

Type	Kleur	Afme- ting a mm	Lengte mm	Verp. m	Gewicht kg/100 m	Bestelnr.
LKV D 100	steengrijs	100	2000	12	34,500	6178512
PVC Polyvinylchloride € / m						

### Bedradingskoker, type 75025

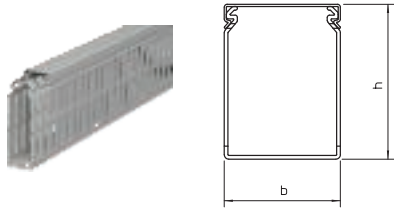

Type	Kleur	Lengte mm	Af-meting B x H mm	Verp. m	Gewicht kg/100 m	Bestelnr.
<b>LKV N 75025</b>	steengrijs	2000	25x75	40	49,500	<b>6178420</b>
PVC Polyvinylchloride € / m						

### Deksel

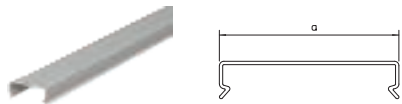

Type	Kleur	Af-meting a mm	Lengte mm	Verp. m	Gewicht kg/100 m	Bestelnr.
<b>LKV D 37</b>	steengrijs	37,5	2000	24	15,000	<b>6178506</b>
PVC Polyvinylchloride € / m						

### Bedradingskoker, type 75050

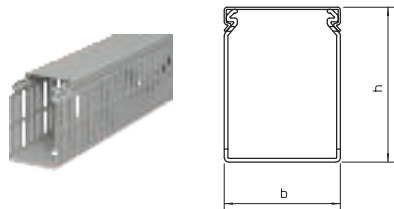

Type	Kleur	Lengte mm	Af-meting B x H mm	Verp. m	Gewicht kg/100 m	Bestelnr.
<b>LKV N 75050</b>	steengrijs	2000	50x75	24	72,500	<b>6178424</b>
PVC Polyvinylchloride € / m						

### Deksel

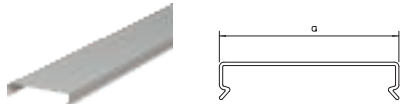

Type	Kleur	Af-meting a mm	Lengte mm	Verp. m	Gewicht kg/100 m	Bestelnr.
<b>LKV D 75</b>	steengrijs	75	2000	12	23,000	<b>6178510</b>
PVC Polyvinylchloride € / m						

### Deksel

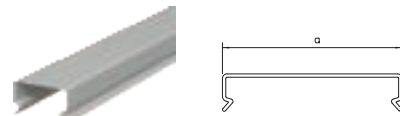

Type	Kleur	Af-meting a mm	Lengte mm	Verp. m	Gewicht kg/100 m	Bestelnr.
<b>LKV D 25</b>	steengrijs	25	2000	36	9,500	<b>6178504</b>
PVC Polyvinylchloride € / m						

### Bedradingskoker, type 75037

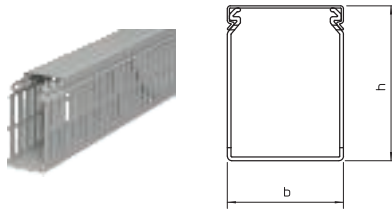

Type	Kleur	Lengte mm	Af-meting B x H mm	Verp. m	Gewicht kg/100 m	Bestelnr.
<b>LKV N 75037</b>	steengrijs	2000	37,5x75	32	60,500	<b>6178422</b>
PVC Polyvinylchloride € / m						

### Deksel

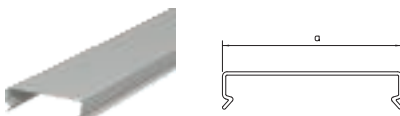

Type	Kleur	Af-meting a mm	Lengte mm	Verp. m	Gewicht kg/100 m	Bestelnr.
<b>LKV D 50</b>	steengrijs	50	2000	24	17,500	<b>6178508</b>
PVC Polyvinylchloride € / m						

### Bedradingskoker, type 75075

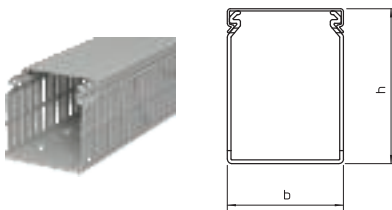

Type	Kleur	Lengte mm	Af-meting B x H mm	Verp. m	Gewicht kg/100 m	Bestelnr.
<b>LKV N 75075</b>	steengrijs	2000	75x75	16	84,500	<b>6178426</b>
PVC Polyvinylchloride € / m						

### Bedradingskoker, type 75100

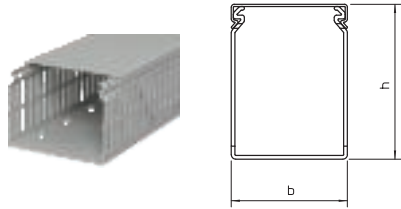

Type	Kleur	Lengte mm	Af- meting B x H mm	Verp. m	Gewicht kg/100 m	Bestelnr.
<b>LKV N 75100</b>	steengrijs	2000	100x75	16	112,000	<b>6178428</b>
PVC Polyvinylchloride € / m						

### Deksel

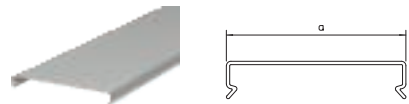

Type	Kleur	Af- meting a mm	Lengte mm	Verp. m	Gewicht kg/100 m	Bestelnr.
<b>LKV D 125</b>	steengrijs	125	2000	16	47,000	<b>6178514</b>
PVC Polyvinylchloride € / m						

### Bedradingskoker, type 10037

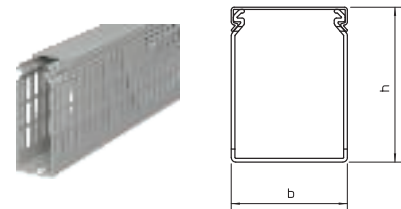

Type	Kleur	Lengte mm	Af- meting B x H mm	Verp. m	Gewicht kg/100 m	Bestelnr.
<b>LKV N 10037</b>	steengrijs	2000	37,5x100	32	73,000	<b>6178435</b>
PVC Polyvinylchloride € / m						

### Deksel

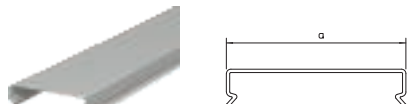

Type	Kleur	Af- meting a mm	Lengte mm	Verp. m	Gewicht kg/100 m	Bestelnr.
<b>LKV D 50</b>	steengrijs	50	2000	24	17,500	<b>6178508</b>
PVC Polyvinylchloride € / m						

### Deksel

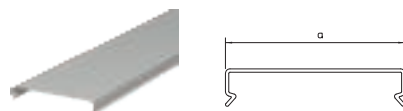

Type	Kleur	Af- meting a mm	Lengte mm	Verp. m	Gewicht kg/100 m	Bestelnr.
<b>LKV D 100</b>	steengrijs	100	2000	12	34,500	<b>6178512</b>
PVC Polyvinylchloride € / m						

### Bedradingskoker, type 75125

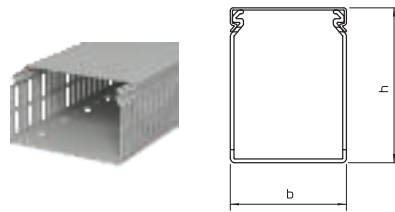

Type	Kleur	Lengte mm	Af- meting B x H mm	Verp. m	Gewicht kg/100 m	Bestelnr.
<b>LKV N 75125</b>	steengrijs	2000	125x75	8	138,500	<b>6178430</b>
PVC Polyvinylchloride € / m						

### Deksel

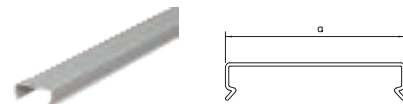

Type	Kleur	Af- meting a mm	Lengte mm	Verp. m	Gewicht kg/100 m	Bestelnr.
<b>LKV D 37</b>	steengrijs	37,5	2000	24	15,000	<b>6178506</b>
PVC Polyvinylchloride € / m						

### Bedradingskoker, type 10050

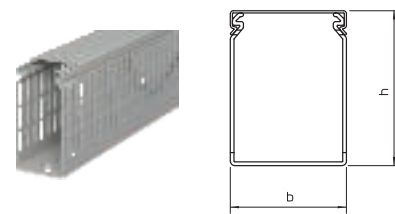

Type	Kleur	Lengte mm	Af- meting B x H mm	Verp. m	Gewicht kg/100 m	Bestelnr.
<b>LKV N 10050</b>	steengrijs	2000	50x100	24	83,000	<b>6178437</b>
PVC Polyvinylchloride € / m						

### Bedradingskoker, type 10075

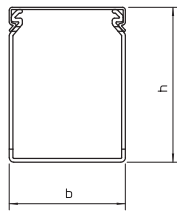

Type	Kleur	Lengte mm	Af- meting B x H mm	Verp. m	Gewicht kg/100 m	Bestelnr.
<b>LKV N 10075</b>	steengrijs	2000	75x100	16	102,000	<b>6178439</b>
PVC Polyvinylchloride € / m						

### Deksel

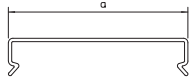

Type	Kleur	Af- meting a mm	Lengte mm	Verp. m	Gewicht kg/100 m	Bestelnr.
<b>LKV D 100</b>	steengrijs	100	2000	12	34,500	<b>6178512</b>
PVC Polyvinylchloride € / m						

### Deksel

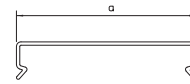

Type	Kleur	Af- meting a mm	Lengte mm	Verp. m	Gewicht kg/100 m	Bestelnr.
<b>LKV D 75</b>	steengrijs	75	2000	12	23,000	<b>6178510</b>
PVC Polyvinylchloride € / m						

### Bedradingskoker, type 100100

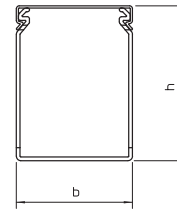

Type	Kleur	Lengte mm	Af- meting B x H mm	Verp. m	Gewicht kg/100 m	Bestelnr.
<b>LKV N 100100</b>	steengrijs	2000	100x100	8	122,500	<b>6178441</b>
PVC Polyvinylchloride € / m						

### Draadhouderbrug voor type LK4 en LK4/N

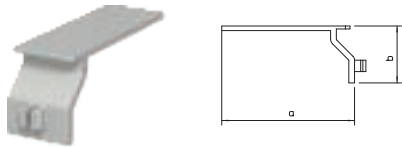

Type	Kleur	Afmeting a mm	Afmeting b mm	Verp. Stuk	Gewicht kg/100 st.	Bestelnr.
<b>LK4 H</b>	steengrijs	56	25	100	0,348	<b>6178092</b>
<b>PS</b> Polystyreen						€/100 st.

### Draadhouderbrug voor type LKV en LKV/N

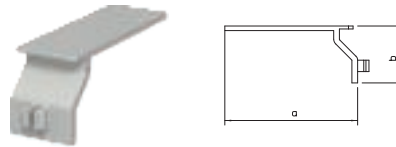

Type	Kleur	Afmeting a mm	Afmeting b mm	Verp. Stuk	Gewicht kg/100 st.	Bestelnr.
<b>LKV H</b>	steengrijs	56	25	100	0,470	<b>6178349</b>
<b>PS</b> Polystyreen						€/100 st.

### Kunststof nietapparaat

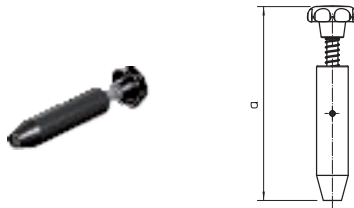

Type	Dimensie	Kleur	Verp. Stuk	Gewicht kg/100 st.	Bestelnr.
<b>KNW1</b>	Ø 4,5mm	zwart	1	9,300	<b>6178527</b>
<b>POM</b> Polyacetal (polyoxymethyleen, polyformaldehyde)					

€/st.

### Kunststof nietapparaat

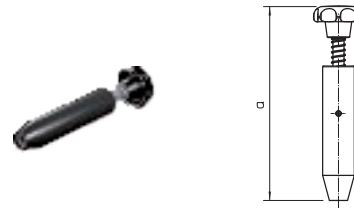

Type	Dimensie	Kleur	Verp. Stuk	Gewicht kg/100 st.	Bestelnr.
<b>KNW2</b>	Ø 6mm	zwart	1	9,400	<b>6178529</b>
<b>POM</b> Polyacetal (polyoxymethyleen, polyformaldehyde)					

€/st.

### Splijtnagel, KSN 1

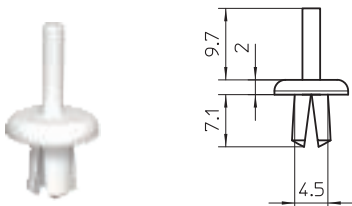

Type	Kleur	Afmeting a mm	Verp. Stuk	Gewicht kg/100 st.	Bestelnr.
<b>KSN1</b>	lichtgrijs	4,5	100	0,026	<b>6178520</b>
<b>PP</b> Polypropyleen					

€/100 st.

### Splijtnagel, KSN 22

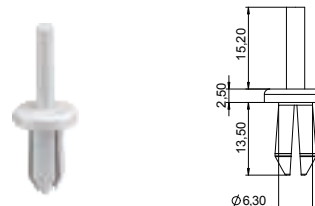

Type	Kleur	Afmeting a mm	Verp. Stuk	Gewicht kg/100 st.	Bestelnr.
<b>KSN22</b>	lichtgrijs	6,3	100	0,070	<b>6178525</b>
<b>PA</b> Polyamide					

€/100 st.

### Uitbrektang



Type	Verp. Stuk	Gewicht kg/100 st.	Bestelnr.
<b>AKZ</b>	1	30,857	<b>6178535</b>
<b>St</b> Staal			

€/st.

### Afstandshouder

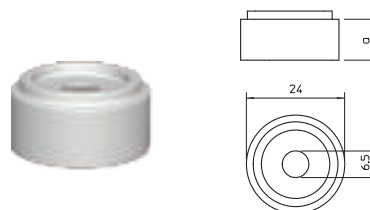

Type	Kleur	Afmeting a mm	Diameter mm	Verp. Stuk	Gewicht kg/100 st.	Bestelnr.
<b>AH1</b>	grijs	12	24	100	0,354	<b>6178540</b>
<b>AH2</b>	grijs	20	24	100	0,577	<b>6178542</b>
<b>PVC</b> Polyvinylchloride						€/100 st.



### Nivelleerring

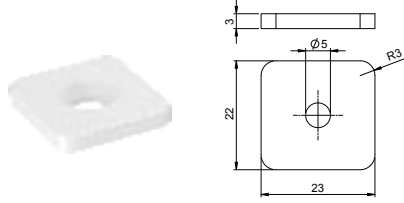

Type	Kleur	Afmeting h mm	Diameter mm	Verp. Stuk	Gewicht kg/100 st.	Bestelnr.
ULS	grijs	3	5	100	0,170	6178548

PVC Polyvinylchloride € /100 st.

### Draagrail, geperforeerd

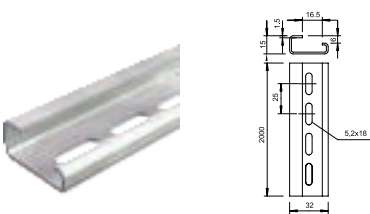

Type	Uitvoering	Materiaal-dikte mm	Lengte mm	Bundel m	Gewicht kg/100 m	Bestelnr.
2064 GTP	geperforeerd	1,5	2000	20	69,000	1115065

Staal € /100 m  
GTP galvanisch verzinkt, transparant gepassiveerd

### DIN-rail, geperforeerd

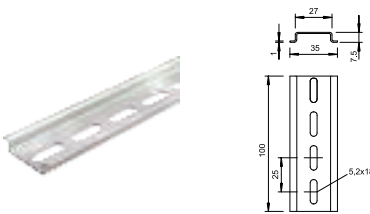

Type	Uitvoering	Materiaal-dikte mm	Lengte mm	Bundel m	Gewicht kg/100 m	Bestelnr.
2069 2M GTP	geperforeerd	1	2000	50	33,280	1115669

Staal € /100 m  
GTP galvanisch verzinkt, transparant gepassiveerd

### Draagrail, niet geperforeerd

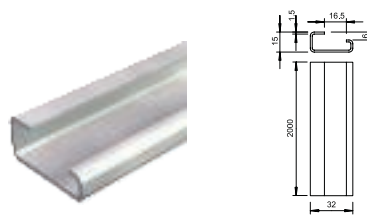

Type	Uitvoering	Materiaal-dikte mm	Lengte mm	Bundel m	Gewicht kg/100 m	Bestelnr.
2064 GTP	2M ongeperforeerd	1,5	2000	20	70,000	1115057

Staal € /100 m  
GTP galvanisch verzinkt, transparant gepassiveerd

### DIN-rail, niet geperforeerd

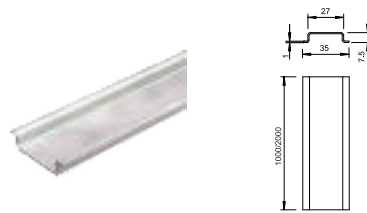

Type	Uitvoering	Materiaal-dikte mm	Lengte mm	Bundel m	Gewicht kg/100 m	Bestelnr.
2069 2M GTP	ongeperforeerd	1	2000	50	36,040	1115650

Staal € /100 m  
GTP galvanisch verzinkt, transparant gepassiveerd

### Coderingsplaat

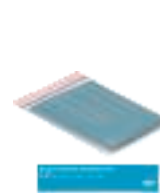

Type	Afmeting mm	Kleur	Verp. Stuk	Gewicht kg/100 st.	Bestelnr.	
VK ISCS	5012	99x25mm	lichtblauw	20	0,100	6178643

€/st.



VKH bedradingskoker  
Halogeenvrij

## VKH bedradingskoker, halogeenvrij



**LKVH DIN bedradingskoker, halogeenvrij**

36



**Toebehoren VK bedradingskoker halogeenvrij**

38

### Bedradingskoker, type 50037

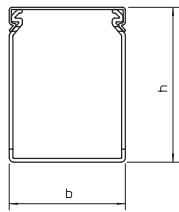

Type	Kleur	Lengte mm	B x H mm	Verp. m	Gewicht kg/100 m	Bestelnr.
LKVH 50037	lichtgrijs	2000	37,5x50	48	32,000	6178582
PC/ABS Polycarbonaat/acrylnitriël-butadiëen-styrol € / m						

### Deksel

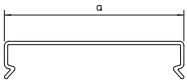

Type	Kleur	Afmeting a mm	Lengte mm	Verp. m	Gewicht kg/100 m	Bestelnr.
LKVH D 50	lichtgrijs	50	2000	24	11,000	6178674
PC/ABS Polycarbonaat/acrylnitriël-butadiëen-styrol € / m						

### Bedradingskoker, type 50075

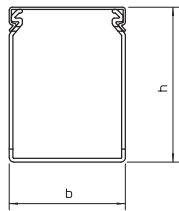

Type	Kleur	Lengte mm	B x H mm	Verp. m	Gewicht kg/100 m	Bestelnr.
LKVH 50075	lichtgrijs	2000	75x50	24	52,000	6178588
PC/ABS Polycarbonaat/acrylnitriël-butadiëen-styrol € / m						

### Deksel

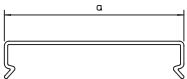

Type	Kleur	Afmeting a mm	Lengte mm	Verp. m	Gewicht kg/100 m	Bestelnr.
LKVH D 37	lichtgrijs	37,5	2000	24	8,500	6178670
PC/ABS Polycarbonaat/acrylnitriël-butadiëen-styrol € / m						

### Deksel

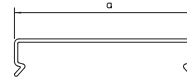

Type	Kleur	Afmeting a mm	Lengte mm	Verp. m	Gewicht kg/100 m	Bestelnr.
LKVH D 37	lichtgrijs	37,5	2000	24	8,500	6178670
PC/ABS Polycarbonaat/acrylnitriël-butadiëen-styrol € / m						

### Bedradingskoker, type 50050

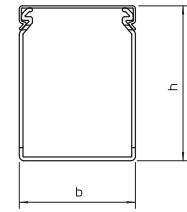

Type	Kleur	Lengte mm	B x H mm	Verp. m	Gewicht kg/100 m	Bestelnr.
LKVH 50050	lichtgrijs	2000	50x50	36	37,000	6178585
PC/ABS Polycarbonaat/acrylnitriël-butadiëen-styrol € / m						

### Deksel

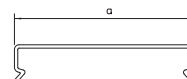

Type	Kleur	Afmeting a mm	Lengte mm	Verp. m	Gewicht kg/100 m	Bestelnr.
LKVH D 75	lichtgrijs	75	2000	12	18,000	6178678
PC/ABS Polycarbonaat/acrylnitriël-butadiëen-styrol € / m						

### Bedradingskoker, type 75037

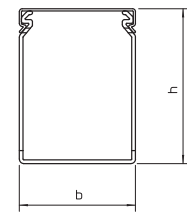

Type	Kleur	Lengte mm	B x H mm	Verp. m	Gewicht kg/100 m	Bestelnr.
LKVH N 75037	lichtgrijs	2000	37,5x75	32	44,000	6178552
PC/ABS Polycarbonaat/acrylnitriël-butadiëen-styrol € / m						

### Bedradingskoker, type 75050

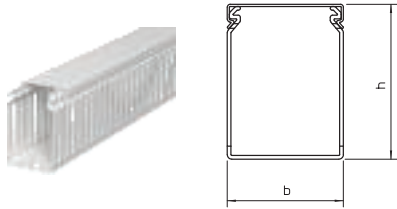

Type	Kleur	Lengte mm	Af-meting B x H mm	Verp. m	Gewicht kg/100 m	Bestelnr.
LKVH N 75050	lichtgrijs	2000	50x75	24	51,000	6178556

PC/ABS Polycarbonaat/acrylnitriël-butadiëen-styrol € /m

### Deksel

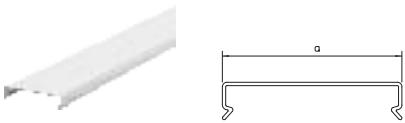

Type	Kleur	Af-meting a mm	Lengte mm	Verp. m	Gewicht kg/100 m	Bestelnr.
LKVH D 75	lichtgrijs	75	2000	12	18,000	6178678

PC/ABS Polycarbonaat/acrylnitriël-butadiëen-styrol € /m

### Bedradingskoker, type 75100

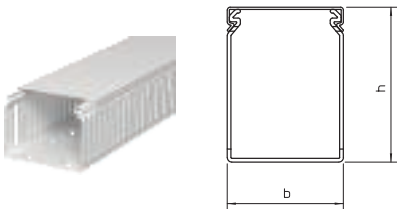

Type	Kleur	Lengte mm	Af-meting B x H mm	Verp. m	Gewicht kg/100 m	Bestelnr.
LKVH N 75100	lichtgrijs	2000	100x75	16	84,000	6178563

PC/ABS Polycarbonaat/acrylnitriël-butadiëen-styrol € /m

### Deksel



Type	Kleur	Af-meting a mm	Lengte mm	Verp. m	Gewicht kg/100 m	Bestelnr.
LKVH D 125	lichtgrijs	125	2000	16	34,500	6178686

PC/ABS Polycarbonaat/acrylnitriël-butadiëen-styrol € /m

### Deksel

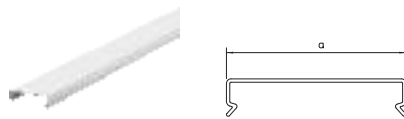

Type	Kleur	Af-meting a mm	Lengte mm	Verp. m	Gewicht kg/100 m	Bestelnr.
LKVH D 50	lichtgrijs	50	2000	24	11,000	6178674

PC/ABS Polycarbonaat/acrylnitriël-butadiëen-styrol € /m

### Bedradingskoker, type 75075

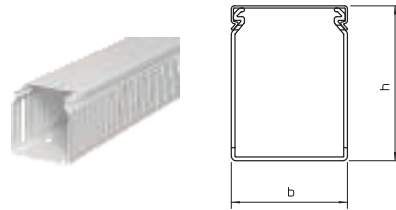

Type	Kleur	Lengte mm	Af-meting B x H mm	Verp. m	Gewicht kg/100 m	Bestelnr.
LKVH N 75075	lichtgrijs	2000	75x75	16	64,000	6178559

PC/ABS Polycarbonaat/acrylnitriël-butadiëen-styrol € /m

### Deksel

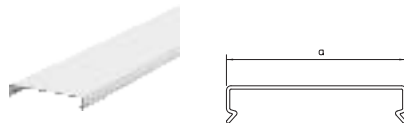

Type	Kleur	Af-meting a mm	Lengte mm	Verp. m	Gewicht kg/100 m	Bestelnr.
LKVH D 100	lichtgrijs	100	2000	12	27,500	6178682

PC/ABS Polycarbonaat/acrylnitriël-butadiëen-styrol € /m

### Bedradingskoker, type 75125

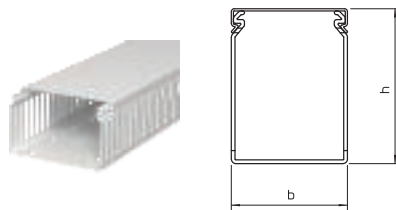

Type	Kleur	Lengte mm	Af-meting B x H mm	Verp. m	Gewicht kg/100 m	Bestelnr.
LKVH N 75125	lichtgrijs	2000	125x75	8	98,500	6178566

PC/ABS Polycarbonaat/acrylnitriël-butadiëen-styrol € /m

### Draadhouderbrug voor type LKV/H

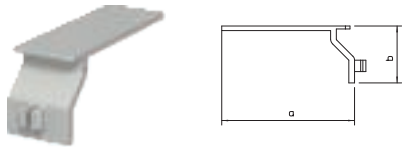

Type	Kleur	Afmeting a mm	Afmeting b mm	Verp. Stuk	Gewicht kg/100 st.	Bestelnr.
<b>LKV H H</b>	lichtgrijs	56	25	100	0,349	<b>6178650</b>

PS Polystyreen € /100 st.

### Splijtnagel, KSN 1

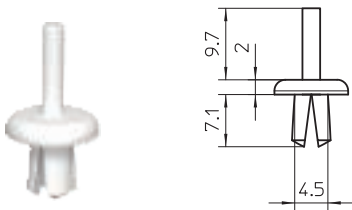

Type	Kleur	Afmeting a mm	Verp. Stuk	Gewicht kg/100 st.	Bestelnr.
<b>KSN1</b>	lichtgrijs	4,5	100	0,026	<b>6178520</b>

PP Polypropyleen € /100 st.

### Uitbrektang



Type	Verp. Stuk	Gewicht kg/100 st.	Bestelnr.
<b>AKZ</b>	1	30,857	<b>6178535</b>

St Staal € /st.

### Draagrail, geperforeerd

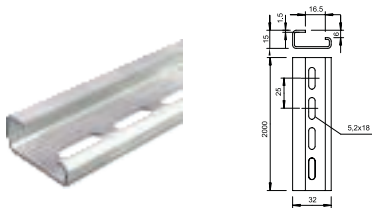

Type	Uitvoering	Materiaal-dikte mm	Lengte mm	Bundel m	Gewicht kg/100 m	Bestelnr.
<b>2064 GTP L 2M</b>	geperforeerd	1,5	2000	20	69,000	<b>1115065</b>

St Staal € /100 m  
GTP galvanisch verzinkt, transparant gepasseveerd

### Kunststof nietapparaat

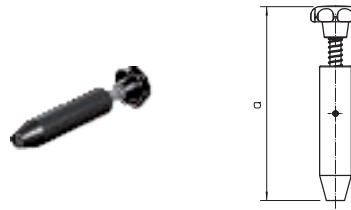

Type	Dimensie	Kleur	Verp. Stuk	Gewicht kg/100 st.	Bestelnr.
<b>KNW1</b>	Ø 4,5mm	zwart	1	9,300	<b>6178527</b>

POM Polyacetal (polyoxymethyleen, polyformaldehyde) € /st.

### Kunststof nietapparaat

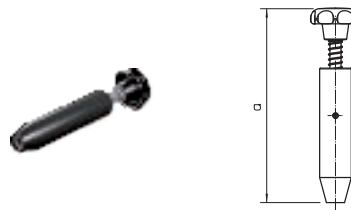

Type	Dimensie	Kleur	Verp. Stuk	Gewicht kg/100 st.	Bestelnr.
<b>KNW2</b>	Ø 6mm	zwart	1	9,400	<b>6178529</b>

POM Polyacetal (polyoxymethyleen, polyformaldehyde) € /st.

### Splijtnagel, KSN 22

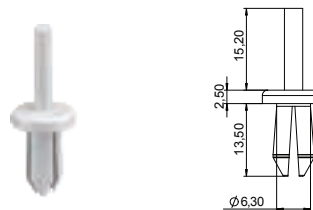

Type	Kleur	Afmeting a mm	Verp. Stuk	Gewicht kg/100 st.	Bestelnr.
<b>KSN22</b>	lichtgrijs	6,3	100	0,070	<b>6178525</b>

PA Polyamide € /100 st.

### Draagrail, niet geperforeerd

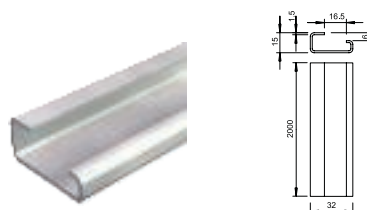

Type	Uitvoering	Materiaal-dikte mm	Lengte mm	Bundel m	Gewicht kg/100 m	Bestelnr.
<b>2064 GTP 2M</b>	ongeperforeerd	1,5	2000	20	70,000	<b>1115057</b>

St Staal € /100 m  
GTP galvanisch verzinkt, transparant gepasseveerd

### DIN-rail, niet geperforeerd

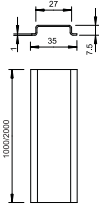

Mate-  
riaal-  
dikte

Type	Uitvoering	mm	Lengte mm	Bundel m	Gewicht kg/100 m	Bestelnr.
<b>2069 2M GTP</b>	ongeperforeerd	1	2000	50	36,040	<b>1115650</b>

**St** Staal

€/100 m

**GTP** galvanisch verzinkt, transparant gepassiveerd

### DIN-rail, geperforeerd

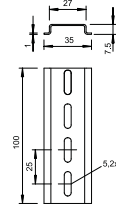

Mate-  
riaal-  
dikte

Type	Uitvoering	mm	Lengte mm	Bundel m	Gewicht kg/100 m	Bestelnr.
<b>2069 2M GTPL</b>	geperforeerd	1	2000	50	33,280	<b>1115669</b>

**St** Staal

€/100 m

**GTP** galvanisch verzinkt, transparant gepassiveerd

OBO Bettermann B.V.  
Postbus 114  
3640 AC Mijdrecht

Klantenservice:  
Tel.: 0297-515700  
Fax: 0297-515760  
E-mail: [info@obo-bettermann.nl](mailto:info@obo-bettermann.nl)

[www.obo-bettermann.nl](http://www.obo-bettermann.nl)

---

**Building Connections**

